



BSPOD075

BS 8620 Podium

(H)1.76 X (L)1.37m X (W)0.65m

Working Height

2.75m

Platform Height

0.75m

Tower Components

Item	Description	Quantity
1	Podium Mainframe	1
2	Self Closing Gates	1
3	Platform	1
4	Stabilisers	2
5	Ladder	1
6	Instruction Manual	1

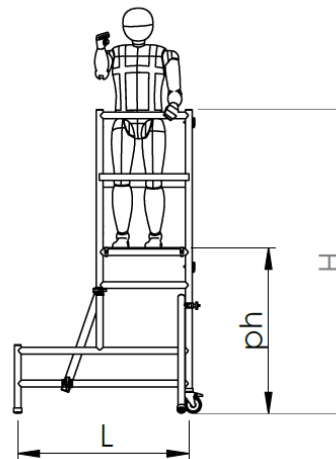
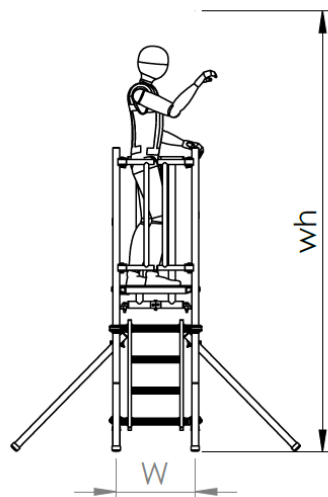
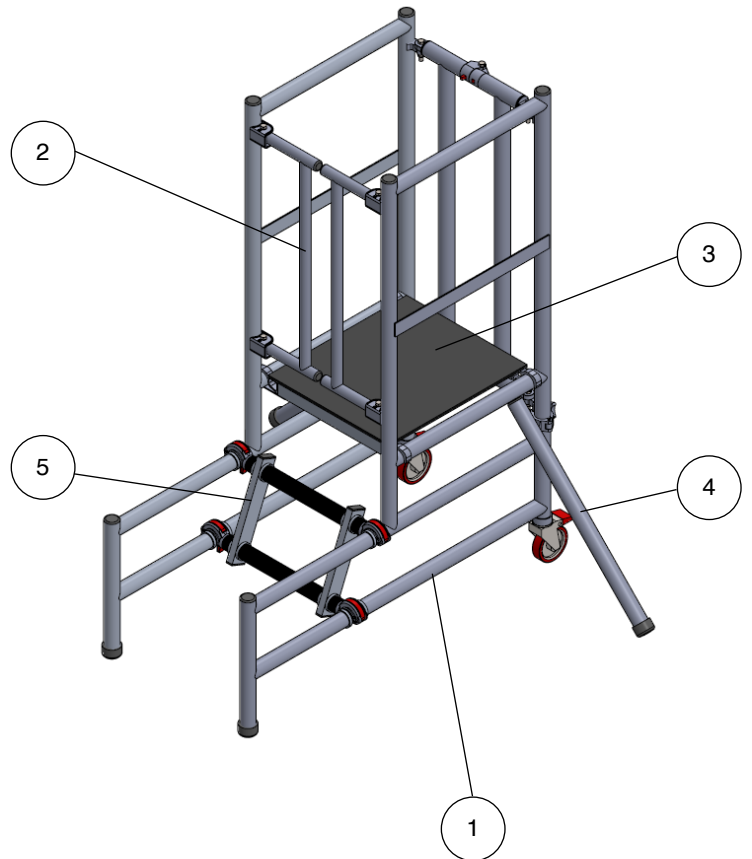

Technical information:

Open Dimensions:	(H)1.76 X (L)1.37m X (W)0.65m
Storage Dimensions:	(H)1.76 X (L)1.37m X (W)0.26m
Platform Dimensions:	0.6m X 0.53m
Platform Height (ph):	0.5m 0.75m
Working Height (wh):	2.5m 2.75m
Maximum Working Load:	150kg
Weight:	31kg